

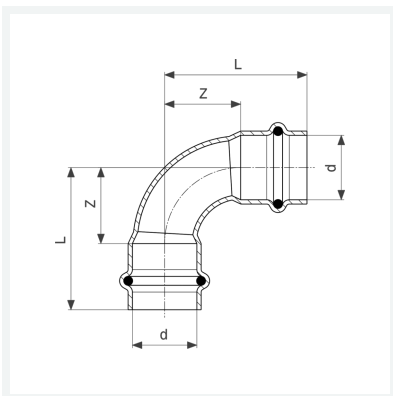

Sanpress Inox bocht 90° met SC-Contur
- persaan sluitingen
uitvoering
afdichtingselementen EPDM
model 2316

artikel 435 653



Eigenschappen

VdS-toelating	VdS	✓
Buisbuitendiameter	d	22
Z-maat	Z	26 mm
Lengte	L	49 mm
Z-maat (eerdere versie)	Z*	44 mm
Lengte (eerdere versie)	L*	67 mm
Gewicht	82 g	
Volume	177,6 cm ³	
Werkstof	roestvast staal	