



Viega Smartpress schroefkoppeling met SC-Contur

- persaansluiting, G-draad

uitvoering

vlakke afdichting EPDM

model 6763

artikel 733 469

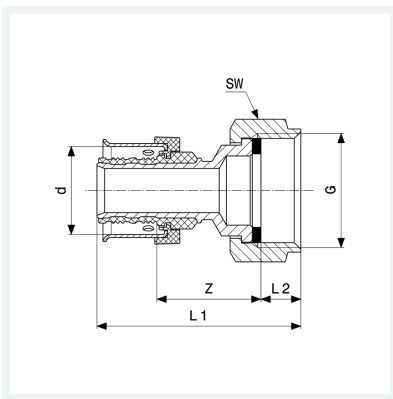

Eigenschappen

Buisbuitendiameter	d	50
Draad cilindrisch	G	1¼
Z-maat	Z	50 mm
Lengte 1	L1	89 mm
Lengte 2	L2	10 mm
Sleutelwijdte	SW	59 mm
Gewicht	315 g	
Volume	621,6 cm ³	
Werkstof	brons	