

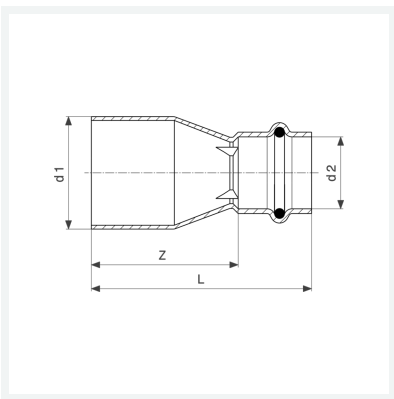

Profipress reductiestuk met SC-Contour
- spie-eind, persaansluiting
uitvoering
afdichtingselement EPDM
model 2415.1

artikel 296 490



Eigenschappen

VdS-toelating	VdS	✓
Buisbuitendiameter 1	d1	35
Buisbuitendiameter 2	d2	28
Z-maat	Z	39 mm
Lengte	L	63 mm
Gewicht	84,4 g	
Volume	165,76 cm ³	
Werkstof	koper	